

1. The genotypes of a Husband and Wife are $I^A I^B$ and $I^A i$.
Among the blood types of their children, how many different genotypes and phenotypes are possible ?
- (1) 4 genotypes ; 3 phenotypes
 - (2) 4 genotypes ; 4 phenotypes
 - (3) 3 genotypes ; 3 phenotypes
 - (4) 3 genotypes ; 4 phenotypes
2. Adult human RBCs are enucleate. Which of the following statement(s) is/are **most appropriate** explanation for this feature ?
- (a) They do not need to reproduce
 - (b) They are somatic cells
 - (c) They do not metabolize
 - (d) All their internal space is available for oxygen transport
- Options :**
- (1) (a), (c) and (d)
 - (2) (b) and (c)
 - (3) Only (d)
 - (4) Only (a)
3. An important characteristic that Hemichordates share with Chordates is :
- (1) pharynx with gill slits
 - (2) pharynx without gill slits
 - (3) absence of notochord
 - (4) ventral tubular nerve cord
4. Good vision depends on adequate intake of carotene-rich food.
Select the best option from the following statements.
- (a) Vitamin A derivatives are formed from carotene.
 - (b) The photopigments are embedded in the membrane discs of the inner segment.
 - (c) Retinal is a derivative of Vitamin A.
 - (d) Retinal is a light absorbing part of all the visual photopigments.
- Options :**
- (1) (a) and (c)
 - (2) (b), (c) and (d)
 - (3) (a) and (b)
 - (4) (a), (c) and (d)
5. Zygotic meiosis is characteristic of :
- (1) *Funaria*
 - (2) *Chlamydomonas*
 - (3) *Marchantia*
 - (4) *Fucus*
6. A decrease in blood pressure/volume will **not** cause the release of :
- (1) Aldosterone
 - (2) ADH
 - (3) Renin
 - (4) Atrial Natriuretic Factor
7. Lungs are made up of air-filled sacs, the alveoli. They do not collapse even after forceful expiration, because of :
- (1) Tidal Volume
 - (2) Expiratory Reserve Volume
 - (3) Residual Volume
 - (4) Inspiratory Reserve Volume
8. Which one of the following statements is **correct**, with reference to enzymes ?
- (1) Coenzyme = Apoenzyme + Holoenzyme
 - (2) Holoenzyme = Coenzyme + Co-factor
 - (3) Apoenzyme = Holoenzyme + Coenzyme
 - (4) Holoenzyme = Apoenzyme + Coenzyme
9. Mycorrhizae are the example of :
- (1) Antibiosis
 - (2) Mutualism
 - (3) Fungistasis
 - (4) Amensalism
10. Which of the following are **not** polymeric ?
- (1) Polysaccharides
 - (2) Lipids
 - (3) Nucleic acids
 - (4) Proteins

11. Which among the following are the smallest living cells, known without a definite cell wall, pathogenic to plants as well as animals and can survive without oxygen ?
- (1) Mycoplasma
 - (2) Nostoc
 - (3) Bacillus
 - (4) Pseudomonas
12. Asymptote in a logistic growth curve is obtained when :
- (1) $K > N$
 - (2) $K < N$
 - (3) The value of 'r' approaches zero
 - (4) $K = N$
13. Plants which produce characteristic pneumatophores and show vivipary belong to :
- (1) Psammophytes
 - (2) Hydrophytes
 - (3) Mesophytes
 - (4) Halophytes
14. Identify the **wrong** statement in context of heartwood :
- (1) It conducts water and minerals efficiently
 - (2) It comprises dead elements with highly lignified walls
 - (3) Organic compounds are deposited in it
 - (4) It is highly durable
15. With reference to factors affecting the rate of photosynthesis, which of the following statements is **not** correct ?
- (1) C_3 plants respond to higher temperatures with enhanced photosynthesis while C_4 plants have much lower temperature optimum
 - (2) Tomato is a greenhouse crop which can be grown in CO_2 - enriched atmosphere for higher yield
 - (3) Light saturation for CO_2 fixation occurs at 10% of full sunlight
 - (4) Increasing atmospheric CO_2 concentration up to 0.05% can enhance CO_2 fixation rate
16. Artificial selection to obtain cows yielding higher milk output represents :
- (1) disruptive as it splits the population into two, one yielding higher output and the other lower output.
 - (2) stabilizing followed by disruptive as it stabilizes the population to produce higher yielding cows.
 - (3) stabilizing selection as it stabilizes this character in the population.
 - (4) directional as it pushes the mean of the character in one direction.
17. Which of the following represents order of 'Horse' ?
- (1) Caballus
 - (2) Ferus
 - (3) Equidae
 - (4) Perissodactyla
18. An example of colonial alga is :
- (1) Ulothrix
 - (2) Spirogyra
 - (3) Chlorella
 - (4) Volvox
19. The DNA fragments separated on an agarose gel can be visualised after staining with :
- (1) Aniline blue
 - (2) Ethidium bromide
 - (3) Bromophenol blue
 - (4) Acetocarmine
20. The hepatic portal vein drains blood to liver from :
- (1) Kidneys
 - (2) Intestine
 - (3) Heart
 - (4) Stomach
21. MALT constitutes about _____ percent of the lymphoid tissue in human body.
- (1) 70%
 - (2) 10%
 - (3) 50%
 - (4) 20%

22. Which of the following is **correctly** matched for the product produced by them ?
- (1) *Penicillium notatum* : Acetic acid
 - (2) *Sacchromyces cerevisiae* : Ethanol
 - (3) *Acetobacter aceti* : Antibiotics
 - (4) *Methanobacterium* : Lactic acid
23. Select the **correct** route for the passage of sperms in male frogs :
- (1) Testes → Vasa efferentia → Bidder's canal → Ureter → Cloaca
 - (2) Testes → Vasa efferentia → Kidney → Bidder's canal → Urinogenital duct → Cloaca
 - (3) Testes → Bidder's canal → Kidney → Vasa efferentia → Urinogenital duct → Cloaca
 - (4) Testes → Vasa efferentia → Kidney → Seminal Vesicle → Urinogenital duct → Cloaca
24. A temporary endocrine gland in the human body is :
- (1) Corpus luteum
 - (2) Corpus allatum
 - (3) Pineal gland
 - (4) Corpus cardiacum
25. Homozygous purelines in cattle can be obtained by :
- (1) mating of individuals of different breed.
 - (2) mating of individuals of different species.
 - (3) mating of related individuals of same breed.
 - (4) mating of unrelated individuals of same breed.
26. Which one from those given below is the period for Mendel's hybridization experiments ?
- (1) 1857 - 1869
 - (2) 1870 - 1877
 - (3) 1856 - 1863
 - (4) 1840 - 1850
27. Which of the following cell organelles is responsible for extracting energy from carbohydrates to form ATP ?
- (1) Chloroplast
 - (2) Mitochondrion
 - (3) Lysosome
 - (4) Ribosome
28. The final proof for DNA as the genetic material came from the experiments of :
- (1) Avery, Mcleod and McCarty
 - (2) Hargobind Khorana
 - (3) Griffith
 - (4) Hershey and Chase
29. Select the mismatch :
- (1) *Salvinia* - Heterosporous
 - (2) *Equisetum* - Homosporous
 - (3) *Pinus* - Dioecious
 - (4) *Cycas* - Dioecious
30. Transplantation of tissues/organs fails often due to non-acceptance by the patient's body. Which type of immune-response is responsible for such rejections ?
- (1) Hormonal immune response
 - (2) Physiological immune response
 - (3) Autoimmune response
 - (4) Cell - mediated immune response
31. Which statement is **wrong** for Krebs' cycle ?
- (1) During conversion of succinyl CoA to succinic acid, a molecule of GTP is synthesised
 - (2) The cycle starts with condensation of acetyl group (acetyl CoA) with pyruvic acid to yield citric acid
 - (3) There are three points in the cycle where NAD^+ is reduced to $\text{NADH} + \text{H}^+$
 - (4) There is one point in the cycle where FAD^+ is reduced to FADH_2
32. Which of the following statements is **correct** ?
- (1) The ascending limb of loop of Henle is permeable to water.
 - (2) The descending limb of loop of Henle is permeable to electrolytes.
 - (3) The ascending limb of loop of Henle is impermeable to water.
 - (4) The descending limb of loop of Henle is impermeable to water.

33. In case of poriferans, the spongocoel is lined with flagellated cells called :
- (1) choanocytes
 - (2) mesenchymal cells
 - (3) ostia
 - (4) oscula
34. Select the mismatch :
- (1) *Anabaena* - Nitrogen fixer
 - (2) *Rhizobium* - Alfalfa
 - (3) *Frankia* - *Alnus*
 - (4) *Rhodospirillum* - Mycorrhiza
35. Which cells of 'Crypts of Lieberkuhn' secrete antibacterial lysozyme ?
- (1) Zymogen cells
 - (2) Kupffer cells
 - (3) Argentaffin cells
 - (4) Paneth cells
36. Viroids differ from viruses in having :
- (1) RNA molecules with protein coat
 - (2) RNA molecules without protein coat
 - (3) DNA molecules with protein coat
 - (4) DNA molecules without protein coat
37. Out of 'X' pairs of ribs in humans only 'Y' pairs are true ribs. Select the option that correctly represents values of X and Y and provides their explanation :
- (1) X = 24, Y = 7 True ribs are dorsally attached to vertebral column but are free on ventral side.
 - (2) X = 24, Y = 12 True ribs are dorsally attached to vertebral column but are free on ventral side.
 - (3) X = 12, Y = 7 True ribs are attached dorsally to vertebral column and ventrally to the sternum.
 - (4) X = 12, Y = 5 True ribs are attached dorsally to vertebral column and sternum on the two ends.
38. The region of Biosphere Reserve which is legally protected and where no human activity is allowed is known as :
- (1) Transition zone
 - (2) Restoration zone
 - (3) Core zone
 - (4) Buffer zone
39. Which of the following is made up of dead cells ?
- (1) Phellem
 - (2) Phloem
 - (3) Xylem parenchyma
 - (4) Collenchyma
40. The morphological nature of the edible part of coconut is :
- (1) Endosperm
 - (2) Pericarp
 - (3) Perisperm
 - (4) Cotyledon
41. What is the criterion for DNA fragments movement on agarose gel during gel electrophoresis ?
- (1) Positively charged fragments move to farther end
 - (2) Negatively charged fragments do not move
 - (3) The larger the fragment size, the farther it moves
 - (4) The smaller the fragment size, the farther it moves
42. Presence of plants arranged into well defined vertical layers depending on their height can be seen best in :
- (1) Grassland
 - (2) Temperate Forest
 - (3) Tropical Savannah
 - (4) Tropical Rain Forest
43. A baby boy aged two years is admitted to play school and passes through a dental check - up. The dentist observed that the boy had twenty teeth. Which teeth were absent ?
- (1) Pre-molars
 - (2) Molars
 - (3) Incisors
 - (4) Canines

44. Which of the following components provides sticky character to the bacterial cell ?
- (1) Plasma membrane
 - (2) Glycocalyx
 - (3) Cell wall
 - (4) Nuclear membrane
45. Double fertilization is exhibited by :
- (1) Fungi
 - (2) Angiosperms
 - (3) Gymnosperms
 - (4) Algae
46. In Bougainvillea thorns are the modifications of :
- ✓ (1) Stem
 - (2) Leaf
 - (3) Stipules
 - (4) Adventitious root
47. Which of the following in sewage treatment removes suspended solids ?
- (1) Primary treatment
 - (2) Sludge treatment
 - (3) Tertiary treatment
 - (4) Secondary treatment
48. Receptor sites for neurotransmitters are present on :
- (1) tips of axons
 - (2) post-synaptic membrane
 - (3) membranes of synaptic vesicles
 - (4) pre-synaptic membrane
49. A dioecious flowering plant prevents both :
- (1) Geitonogamy and xenogamy
 - (2) Cleistogamy and xenogamy
 - (3) Autogamy and xenogamy
 - (4) Autogamy and geitonogamy
50. The pivot joint between atlas and axis is a type of :
- (1) synovial joint
 - (2) saddle joint
 - (3) fibrous joint
 - (4) cartilaginous joint
51. The water potential of pure water is :
- (1) More than zero but less than one
 - (2) More than one
 - (3) Zero
 - (4) Less than zero
52. Which ecosystem has the maximum biomass ?
- (1) Pond ecosystem
 - (2) Lake ecosystem
 - (3) Forest ecosystem
 - (4) Grassland ecosystem
53. GnRH, a hypothalamic hormone, needed in reproduction, acts on :
- (1) posterior pituitary gland and stimulates secretion of oxytocin and FSH.
 - (2) posterior pituitary gland and stimulates secretion of LH and relaxin.
 - (3) anterior pituitary gland and stimulates secretion of LH and oxytocin.
 - (4) anterior pituitary gland and stimulates secretion of LH and FSH.
54. Alexander Von Humbolt described for the first time :
- (1) Species area relationships
 - (2) Population Growth equation
 - (3) Ecological Biodiversity
 - (4) Laws of limiting factor
55. Fruit and leaf drop at early stages can be prevented by the application of :
- (1) Auxins
 - (2) Gibberellic acid
 - (3) Cytokinins
 - (4) Ethylene

56. Which of the following facilitates opening of stomatal aperture ?
- Radial orientation of cellulose microfibrils in the cell wall of guard cells
 - Longitudinal orientation of cellulose microfibrils in the cell wall of guard cells
 - Contraction of outer wall of guard cells
 - Decrease in turgidity of guard cells
57. DNA replication in bacteria occurs :
- Prior to fission
 - Just before transcription
 - During S phase
 - Within nucleolus
58. Phosphoenol pyruvate (PEP) is the primary CO_2 acceptor in :
- C_2 plants
 - C_3 and C_4 plants
 - C_3 plants
 - C_4 plants
59. Which of the following options best represents the enzyme composition of pancreatic juice ?
- peptidase, amylase, pepsin, rennin
 - lipase, amylase, trypsinogen, procarboxypeptidase
 - amylase, peptidase, trypsinogen, rennin
 - amylase, pepsin, trypsinogen, maltase
60. Among the following characters, which one was not considered by Mendel in his experiments on pea ?
- Seed - Green or Yellow
 - Pod - Inflated or Constricted
 - Stem - Tall or Dwarf
 - Trichomes - Glandular or non-glandular
61. A gene whose expression helps to identify transformed cell is known as :
- Plasmid
 - Structural gene
 - Selectable marker
 - Vector
62. In case of a couple where the male is having a very low sperm count, which technique will be suitable for fertilisation ?
- Artificial Insemination
 - Intracytoplasmic sperm injection
 - Intrauterine transfer
 - Gamete intracytoplasmic fallopian transfer
63. Match the following sexually transmitted diseases (Column - I) with their causative agent (Column - II) and select the correct option.
- | Column - I | Column - II |
|-------------------|------------------------------|
| (a) Gonorrhoea | (i) HIV |
| (b) Syphilis | (ii) <i>Neisseria</i> |
| (c) Genital Warts | (iii) <i>Treponema</i> |
| (d) AIDS | (iv) Human Papilloma - Virus |
- Options :
- | | (a) | (b) | (c) | (d) |
|-----|-------|-------|-------|------|
| (1) | (iv) | (ii) | (iii) | (i) |
| (2) | (iv) | (iii) | (ii) | (i) |
| (3) | (ii) | (iii) | (iv) | (i) |
| (4) | (iii) | (iv) | (i) | (ii) |
64. Which among these is the correct combination of aquatic mammals ?
- Whales, Dolphins, Seals
 - Trygon*, Whales, Seals
 - Seals, Dolphins, Sharks
 - Dolphins, Seals, *Trygon*
65. Flowers which have single ovule in the ovary and are packed into inflorescence are usually pollinated by :
- Wind
 - Bat
 - Water
 - Bee
66. Life cycle of *Ectocarpus* and *Fucus* respectively are :
- Haplodiplontic, Diplontic
 - Haplodiplontic, Haplontic
 - Haplontic, Diplontic
 - Diplontic, Haplodiplontic

67. The association of histone H1 with a nucleosome indicates :
- (1) The DNA is condensed into a Chromatin Fibre.
 - (2) The DNA double helix is exposed.
 - (3) Transcription is occurring.
 - (4) DNA replication is occurring.
68. During DNA replication, Okazaki fragments are used to elongate :
- (1) The leading strand away from replication fork.
 - (2) The lagging strand away from the replication fork.
 - (3) The leading strand towards replication fork.
 - (4) The lagging strand towards replication fork.
69. Thalassemia and sickle cell anemia are caused due to a problem in globin molecule synthesis. Select the correct statement.
- (1) Thalassemia is due to less synthesis of globin molecules.
 - (2) Sickle cell anemia is due to a quantitative problem of globin molecules.
 - (3) Both are due to a qualitative defect in globin chain synthesis.
 - (4) Both are due to a quantitative defect in globin chain synthesis.
70. Coconut fruit is a :
- (1) Nut
 - (2) Capsule
 - (3) Drupe
 - (4) Berry
71. Attractants and rewards are required for :
- (1) Hydrophily
 - (2) Cleistogamy
 - (3) Anemophily
 - (4) Entomophily
72. Spliceosomes are not found in cells of :
- (1) Animals
 - (2) Bacteria
 - (3) Plants
 - (4) Fungi
73. Hypersecretion of Growth Hormone in adults does not cause further increase in height, because :
- (1) Bones loose their sensitivity to Growth Hormone in adults.
 - (2) Muscle fibres do not grow in size after birth.
 - (3) Growth Hormone becomes inactive in adults.
 - (4) Epiphyseal plates close after adolescence.
74. Which one of the following statements is not valid for aerosols ?
- (1) They cause increased agricultural productivity
 - (2) They have negative impact on agricultural land
 - (3) They are harmful to human health
 - (4) They alter rainfall and monsoon patterns
75. The vascular cambium normally gives rise to :
- (1) Secondary xylem
 - (2) Periderm
 - (3) Phelloderm
 - (4) Primary phloem
76. If there are 999 bases in an RNA that codes for a protein with 333 amino acids, and the base at position 901 is deleted such that the length of the RNA becomes 998 bases, how many codons will be altered ?
- (1) 33
 - (2) 333
 - (3) 1
 - (4) 11
77. Which of the following are found in extreme saline conditions ?
- (1) Cyanobacteria
 - (2) Mycobacteria
 - (3) Archaeobacteria
 - (4) Eubacteria
78. The process of separation and purification of expressed protein before marketing is called :
- (1) Bioprocessing
 - (2) Postproduction processing
 - (3) Upstream processing
 - (4) Downstream processing

79. Capacitation occurs in :
- (1) Vas deferens
 - (2) Female Reproductive tract
 - (3) Rete testis
 - (4) Epididymis
80. Functional megaspore in an angiosperm develops into :
- (1) Embryo sac
 - (2) Embryo
 - (3) Ovule
 - (4) Endosperm
81. Anaphase Promoting Complex (APC) is a protein degradation machinery necessary for proper mitosis of animal cells. If APC is defective in a human cell, which of the following is expected to occur ?
- (1) Chromosomes will not segregate
 - (2) Recombination of chromosome arms will occur
 - (3) Chromosomes will not condense
 - (4) Chromosomes will be fragmented
82. Myelin sheath is produced by :
- (1) Oligodendrocytes and Osteoclasts
 - (2) Osteoclasts and Astrocytes
 - (3) Schwann Cells and Oligodendrocytes
 - (4) Astrocytes and Schwann Cells
83. Which of the following options gives the correct sequence of events during mitosis ?
- (1) condensation → crossing over → nuclear membrane disassembly → segregation → telophase
 - (2) condensation → arrangement at equator → centromere division → segregation → telophase
 - (3) condensation → nuclear membrane disassembly → crossing over → segregation → telophase
 - (4) condensation → nuclear membrane disassembly → arrangement at equator → centromere division → segregation → telophase
84. A disease caused by an autosomal primary non-disjunction is :
- (1) Turner's Syndrome
 - (2) Sickle Cell Anemia
 - (3) Down's Syndrome
 - (4) Klinefelter's Syndrome
85. Which one of the following is related to Ex-situ conservation of threatened animals and plants ?
- (1) Amazon rainforest
 - (2) Himalayan region
 - (3) Wildlife Safari parks
 - (4) Biodiversity hot spots
86. The function of copper ions in copper releasing IUD's is :
- (1) They make uterus unsuitable for implantation.
 - (2) They inhibit ovulation.
 - (3) They suppress sperm motility and fertilising capacity of sperms.
 - (4) They inhibit gametogenesis.
87. Which of the following RNAs should be most abundant in animal cell ?
- (1) m-RNA
 - (2) mi-RNA
 - (3) r-RNA
 - (4) t-RNA
88. Root hairs develop from the region of :
- (1) Root cap
 - (2) Meristematic activity
 - (3) Maturation
 - (4) Elongation

89. Frog's heart when taken out of the body continues to beat for sometime.
Select the best option from the following statements.
- Frog is a poikilotherm.
 - Frog does not have any coronary circulation.
 - Heart is "myogenic" in nature.
 - Heart is autoexcitable.
- Options:
- (a) and (b)
 - (c) and (d)
 - Only (c)
 - Only (d)
90. DNA fragments are:
- Neutral
 - Either positively or negatively charged depending on their size
 - Positively charged
 - Negatively charged
91. A first order reaction has a specific reaction rate of 10^{-2} sec^{-1} . How much time will it take for 20 g of the reactant to reduce to 5 g?
- 346.5 sec
 - 693.0 sec
 - 238.6 sec
 - 138.6 sec
92. A gas is allowed to expand in a well insulated container against a constant external pressure of 2.5 atm from an initial volume of 2.50 L to a final volume of 4.50 L. The change in internal energy ΔU of the gas in joules will be:
- 505 J
 - +505 J
 - 1136.25 J
 - 500 J
93. Which one is the correct order of acidity?
- $\text{CH}\equiv\text{CH} > \text{CH}_2=\text{CH}_2 > \text{CH}_3-\text{C}\equiv\text{CH} > \text{CH}_3-\text{CH}_3$
 - $\text{CH}_3-\text{CH}_3 > \text{CH}_2=\text{CH}_2 > \text{CH}_3-\text{C}\equiv\text{CH} > \text{CH}\equiv\text{CH}$
 - $\text{CH}_2=\text{CH}_2 > \text{CH}_3-\text{CH}=\text{CH}_2 > \text{CH}_3-\text{C}\equiv\text{CH} > \text{CH}\equiv\text{CH}$
 - $\text{CH}\equiv\text{CH} > \text{CH}_3-\text{C}\equiv\text{CH} > \text{CH}_2=\text{CH}_2 > \text{CH}_3-\text{CH}_3$
94. Which of the following is a sink for CO?
- Oceans
 - Plants
 - Haemoglobin
 - Micro organisms present in the soil
95. If molality of the dilute solution is doubled, the value of molal depression constant (K_f) will be:
- tripled
 - unchanged
 - doubled
 - halved
96. With respect to the conformers of ethane, which of the following statements is true?
- Both bond angle and bond length change
 - Both bond angles and bond length remains same
 - Bond angle remains same but bond length changes
 - Bond angle changes but bond length remains same
97. Pick out the correct statement with respect to $[\text{Mn}(\text{CN})_6]^{3-}$:
- It is d^2sp^3 hybridised and octahedral
 - It is dsp^2 hybridised and square planar
 - It is sp^3d^2 hybridised and octahedral
 - It is sp^3d^2 hybridised and tetrahedral
98. Which of the following pairs of compounds is isoelectronic and isostructural?
- IBr_2^- , XeF_2
 - IF_3 , XeF_2
 - BeCl_2 , XeF_2
 - TeI_2 , XeF_2

99. Which one of the following statements is not correct?

- (1) Enzymes catalyse mainly bio-chemical reactions.
- (2) Coenzymes increase the catalytic activity of enzyme.
- (3) Catalyst does not initiate any reaction.
- (4) The value of equilibrium constant is changed in the presence of a catalyst in the reaction at equilibrium.

100. Concentration of the Ag^+ ions in a saturated solution of $\text{Ag}_2\text{C}_2\text{O}_4$ is $2.2 \times 10^{-4} \text{ mol L}^{-1}$. Solubility product of $\text{Ag}_2\text{C}_2\text{O}_4$ is:

- (1) 4.5×10^{-11}
- (2) 5.3×10^{-12}
- (3) 2.42×10^{-8}
- (4) 2.66×10^{-12}

101. The reason for greater range of oxidation states in actinoids is attributed to:

- (1) 5f, 6d and 7s levels having comparable energies
- (2) 4f and 5d levels being close in energies
- (3) the radioactive nature of actinoids
- (4) actinoid contraction

102. In the electrochemical cell:

$\text{Zn}|\text{ZnSO}_4 (0.01 \text{ M})||\text{CuSO}_4 (1.0 \text{ M})|\text{Cu}$, the emf of this Daniel cell is E_1 . When the concentration of ZnSO_4 is changed to 1.0 M and that of CuSO_4 changed to 0.01 M, the emf changes to E_2 . From the followings, which one is the relationship between

E_1 and E_2 ? (Given, $\frac{RT}{F} = 0.059$)

- (1) $E_1 > E_2$
- (2) $E_2 = 0 \neq E_1$
- (3) $E_1 = E_2$
- (4) $E_1 < E_2$

103. Identify A and predict the type of reaction

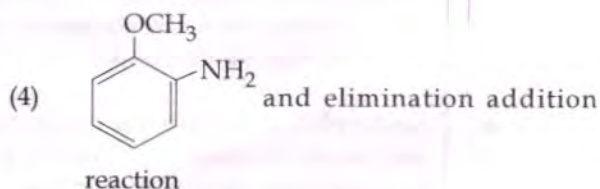
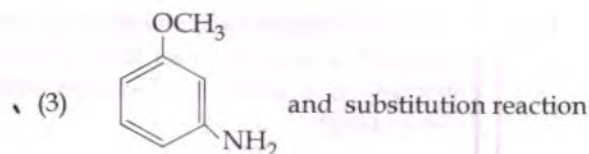
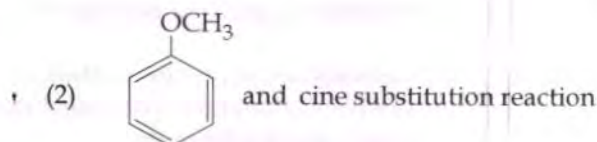
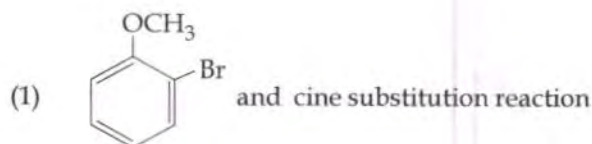
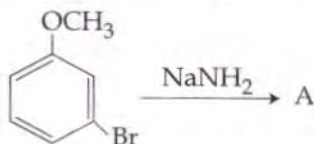

104. Which one is the wrong statement?

- (1) Half filled and fully filled orbitals have greater stability due to greater exchange energy, greater symmetry and more balanced arrangement.
- (2) The energy of 2s orbital is less than the energy of 2p orbital in case of Hydrogen like atoms.
- (3) de-Broglie's wavelength is given by $\lambda = \frac{h}{mv}$, where m = mass of the particle, v = group velocity of the particle.
- (4) The uncertainty principle is $\Delta E \times \Delta t \geq \frac{h}{4\pi}$.

105. The correct order of the stoichiometries of AgCl formed when AgNO_3 in excess is treated with the complexes: $\text{CoCl}_3 \cdot 6\text{NH}_3$, $\text{CoCl}_3 \cdot 5\text{NH}_3$, $\text{CoCl}_3 \cdot 4\text{NH}_3$ respectively is:

- (1) 3 AgCl , 2 AgCl , 1 AgCl
- (2) 2 AgCl , 3 AgCl , 1 AgCl
- (3) 1 AgCl , 3 AgCl , 2 AgCl
- (4) 3 AgCl , 1 AgCl , 2 AgCl

106. Name the gas that can readily decolourise acidified KMnO_4 solution :

- (1) NO_2
- (2) P_2O_5
- (3) CO_2
- (4) SO_2

107. The correct statement regarding electrophile is :

- (1) Electrophiles are generally neutral species and can form a bond by accepting a pair of electrons from a nucleophile
- (2) Electrophile can be either neutral or positively charged species and can form a bond by accepting a pair of electrons from a nucleophile
- (3) Electrophile is a negatively charged species and can form a bond by accepting a pair of electrons from a nucleophile
- (4) Electrophile is a negatively charged species and can form a bond by accepting a pair of electrons from another electrophile

108. The species, having bond angles of 120° is :

- (1) NCl_3
- (2) BCl_3
- (3) PH_3
- (4) ClF_3

109. Which of the following statements is not correct ?

- (1) Blood proteins thrombin and fibrinogen are involved in blood clotting.
- (2) Denaturation makes the proteins more active.
- (3) Insulin maintains sugar level in the blood of a human body.
- (4) Ovalbumin is a simple food reserve in egg-white.

110. Consider the reactions :

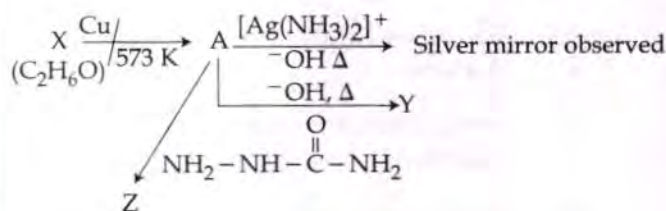

Identify A, X, Y and Z

- (1) A-Ethanal, X-Ethanol, Y-But-2-enal, Z-Semicarbazone.
- (2) A-Ethanol, X-Acetaldehyde, Y-Butanone, Z-Hydrazone.
- (3) A-Methoxymethane, X-Ethanoic acid, Y-Acetate ion, Z-hydrazine.
- (4) A-Methoxymethane, X-Ethanol, Y-Ethanoic acid, Z-Semicarbazide.

111. Mechanism of a hypothetical reaction $\text{X}_2 + \text{Y}_2 \rightarrow 2 \text{XY}$ is given below :

- (i) $\text{X}_2 \rightarrow \text{X} + \text{X}$ (fast)
- (ii) $\text{X} + \text{Y}_2 \rightleftharpoons \text{XY} + \text{Y}$ (slow)
- (iii) $\text{X} + \text{Y} \rightarrow \text{XY}$ (fast)

The overall order of the reaction will be :

- (1) 0
- (2) 1.5
- (3) 1
- (4) 2

112. Which of the following reactions is appropriate for converting acetamide to methanamine ?

- (1) Stephens reaction
- (2) Gabriels phthalimide synthesis
- (3) Carbylamine reaction
- (4) Hoffmann hypobromamide reaction

113. Correct increasing order for the wavelengths of absorption in the visible region for the complexes of Co^{3+} is :

- (1) $[\text{Co}(\text{H}_2\text{O})_6]^{3+}$, $[\text{Co}(\text{NH}_3)_6]^{3+}$, $[\text{Co}(\text{en})_3]^{3+}$
- (2) $[\text{Co}(\text{NH}_3)_6]^{3+}$, $[\text{Co}(\text{en})_3]^{3+}$, $[\text{Co}(\text{H}_2\text{O})_6]^{3+}$
- (3) $[\text{Co}(\text{en})_3]^{3+}$, $[\text{Co}(\text{NH}_3)_6]^{3+}$, $[\text{Co}(\text{H}_2\text{O})_6]^{3+}$
- (4) $[\text{Co}(\text{H}_2\text{O})_6]^{3+}$, $[\text{Co}(\text{en})_3]^{3+}$, $[\text{Co}(\text{NH}_3)_6]^{3+}$

114. Which is the incorrect statement ?

- (1) NaCl(s) is insulator, silicon is semiconductor, silver is conductor, quartz is piezo electric crystal.
- (2) Frenkel defect is favoured in those ionic compounds in which sizes of cation and anions are almost equal.
- (3) $\text{FeO}_{0.98}$ has non stoichiometric metal deficiency defect.
- (4) Density decreases in case of crystals with Schottky's defect.

115. The equilibrium constants of the following are :

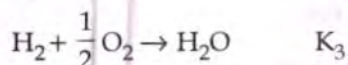
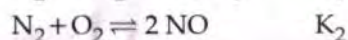
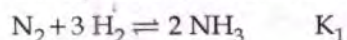

The equilibrium constant (K) of the reaction :

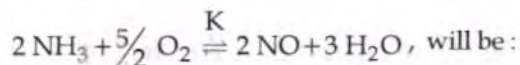

- (1) $K_2 K_3 / K_1$
- (2) $K_2^3 K_3 / K_1$
- (3) $K_1 K_3^3 / K_2$
- (4) $K_2 K_3^3 / K_1$

116. Extraction of gold and silver involves leaching with CN^- ion. Silver is later recovered by :

- (1) zone refining
- (2) displacement with Zn
- (3) liquation
- (4) distillation

117. The most suitable method of separation of 1 : 1 mixture of ortho and para - nitrophenols is :

- (1) Crystallisation
- (2) Steam distillation
- (3) Sublimation
- (4) Chromatography

118. It is because of inability of ns^2 electrons of the valence shell to participate in bonding that :

- (1) Sn^{2+} and Pb^{2+} are both oxidising and reducing
- (2) Sn^{4+} is reducing while Pb^{4+} is oxidising
- (3) Sn^{2+} is reducing while Pb^{4+} is oxidising
- (4) Sn^{2+} is oxidising while Pb^{4+} is reducing

119. An example of a sigma bonded organometallic compound is :

- (1) Ferrocene
- (2) Cobaltocene
- (3) Ruthenocene
- (4) Grignard's reagent

120. For a given reaction, $\Delta H = 35.5 \text{ kJ mol}^{-1}$ and $\Delta S = 83.6 \text{ JK}^{-1} \text{ mol}^{-1}$. The reaction is spontaneous at : (Assume that ΔH and ΔS do not vary with temperature)

- (1) all temperatures
- (2) $T > 298 \text{ K}$
- (3) $T < 425 \text{ K}$
- (4) $T > 425 \text{ K}$

121. Ionic mobility of which of the following alkali metal ions is lowest when aqueous solution of their salts are put under an electric field ?

- (1) Rb
- (2) Li
- (3) Na
- (4) K

122. Which one is the most acidic compound ?

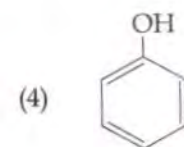
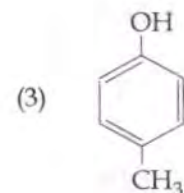
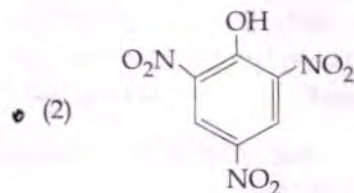
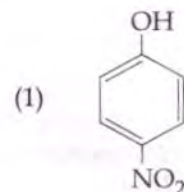

123. Mixture of chloroxylenol and terpineol acts as :

- (1) antipyretic
- (2) antibiotic
- (3) analgesic
- (4) antiseptic

124. Of the following, which is the product formed when cyclohexanone undergoes aldol condensation followed by heating ?

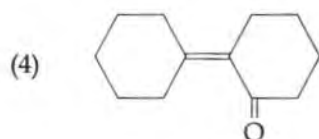
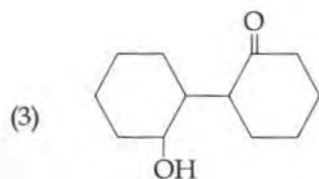
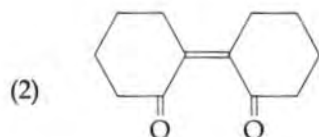
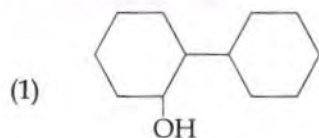

125. The element $Z = 114$ has been discovered recently. It will belong to which of the following family/group and electronic configuration ?

- (1) Oxygen family, $[\text{Rn}] 5f^{14} 6d^{10} 7s^2 7p^4$
- (2) Nitrogen family, $[\text{Rn}] 5f^{14} 6d^{10} 7s^2 7p^6$
- (3) Halogen family, $[\text{Rn}] 5f^{14} 6d^{10} 7s^2 7p^5$
- (4) Carbon family, $[\text{Rn}] 5f^{14} 6d^{10} 7s^2 7p^2$

126. The correct increasing order of basic strength for the following compounds is :

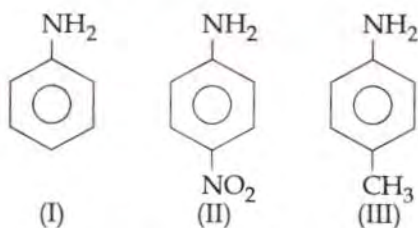

- (1) III < II < I
- (2) II < I < III
- (3) II < III < I
- (4) III < I < II

127. Which of the following is dependent on temperature ?

- (1) Mole fraction
- (2) Weight percentage
- (3) Molality
- (4) Molarity

128. The heating of phenyl-methyl ethers with HI produces.

- (1) phenol
- (2) benzene
- (3) ethyl chlorides
- (4) iodobenzene

129. Predict the correct intermediate and product in the following reaction :

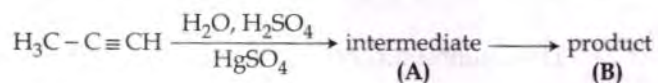

- (1) A : $\text{H}_3\text{C}-\overset{\text{O}}{\parallel}{\text{C}}-\text{CH}_3$ B : $\text{H}_3\text{C}-\text{C}\equiv\text{CH}$
- (2) A : $\text{H}_3\text{C}-\overset{\text{OH}}{\mid}{\text{C}}=\text{CH}_2$ B : $\text{H}_3\text{C}-\overset{\text{O}}{\parallel}{\text{C}}-\text{CH}_3$
- (3) A : $\text{H}_3\text{C}-\overset{\text{SO}_4}{\mid}{\text{C}}=\text{CH}_2$ B : $\text{H}_3\text{C}-\overset{\text{O}}{\parallel}{\text{C}}-\text{CH}_3$
- (4) A : $\text{H}_3\text{C}-\overset{\text{OH}}{\mid}{\text{C}}=\text{CH}_2$ B : $\text{H}_3\text{C}-\overset{\text{SO}_4}{\mid}{\text{C}}=\text{CH}_2$

130. In which pair of ions both the species contain S-S bond ?

- (1) $\text{S}_2\text{O}_7^{2-}, \text{S}_2\text{O}_8^{2-}$
- (2) $\text{S}_4\text{O}_6^{2-}, \text{S}_2\text{O}_7^{2-}$
- (3) $\text{S}_2\text{O}_7^{2-}, \text{S}_2\text{O}_3^{2-}$
- (4) $\text{S}_4\text{O}_6^{2-}, \text{S}_2\text{O}_3^{2-}$

131. HgCl_2 and I_2 both when dissolved in water containing I^- ions the pair of species formed is :

- (1) $\text{HgI}_4^{2-}, \text{I}_3^-$
- (2) $\text{Hg}_2\text{I}_2, \text{I}^-$
- (3) $\text{HgI}_2, \text{I}_3^-$
- (4) HgI_2, I^-

132. A 20 litre container at 400 K contains $\text{CO}_2(\text{g})$ at pressure 0.4 atm and an excess of SrO (neglect the volume of solid SrO). The volume of the container is now decreased by moving the movable piston fitted in the container. The maximum volume of the container, when pressure of CO_2 attains its maximum value, will be:

(Given that : $\text{SrCO}_3(\text{s}) \rightleftharpoons \text{SrO}(\text{s}) + \text{CO}_2(\text{g})$,
 $K_p = 1.6 \text{ atm}$)

- (1) 4 litre
- (2) 2 litre
- (3) 5 litre
- (4) 10 litre

133. Match the interhalogen compounds of column I with the geometry in column II and assign the correct code.

	Column I		Column II
(a)	XX'	(i)	T - shape
(b)	XX'_3	(ii)	Pentagonal bipyramidal
(c)	XX'_5	(iii)	Linear
(d)	XX'_7	(iv)	Square - pyramidal
		(v)	Tetrahedral

Code:

	(a)	(b)	(c)	(d)
(1)	(v)	(iv)	(iii)	(ii)
(2)	(iv)	(iii)	(ii)	(i)
(3)	(iii)	(iv)	(i)	(ii)
(4)	(iii)	(i)	(iv)	(ii)

134. Which one of the following pairs of species have the same bond order?

- (1) CN^- , CO
- (2) N_2 , O_2^-
- (3) CO , NO
- (4) O_2 , NO^+

135. The IUPAC name of the compound

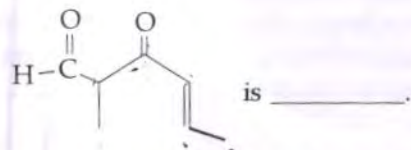

- (1) 5-methyl-4-oxohex-2-en-5-al
- (2) 3-keto-2-methylhex-5-enal
- (3) 3-keto-2-methylhex-4-enal
- (4) 5-formylhex-2-en-3-one

136. Preeti reached the metro station and found that the escalator was not working. She walked up the stationary escalator in time t_1 . On other days, if she remains stationary on the moving escalator, then the escalator takes her up in time t_2 . The time taken by her to walk up on the moving escalator will be:

- (1) $\frac{t_1 t_2}{t_2 + t_1}$
- (2) $t_1 - t_2$
- (3) $\frac{t_1 + t_2}{2}$
- (4) $\frac{t_1 t_2}{t_2 - t_1}$

137. An arrangement of three parallel straight wires placed perpendicular to plane of paper carrying same current 'I' along the same direction is shown in Fig. Magnitude of force per unit length on the middle wire 'B' is given by:

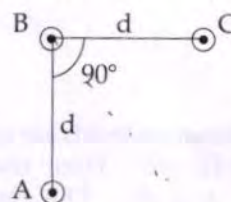

- (1) $\frac{\sqrt{2} \mu_0 i^2}{\pi d}$
- (2) $\frac{\mu_0 i^2}{\sqrt{2} \pi d}$
- (3) $\frac{\mu_0 i^2}{2 \pi d}$
- (4) $\frac{2 \mu_0 i^2}{\pi d}$

138. A particle executes linear simple harmonic motion with an amplitude of 3 cm. When the particle is at 2 cm from the mean position, the magnitude of its velocity is equal to that of its acceleration. Then its time period in seconds is:

- (1) $\frac{4\pi}{\sqrt{5}}$
- (2) $\frac{2\pi}{\sqrt{3}}$
- (3) $\frac{\sqrt{5}}{\pi}$
- (4) $\frac{\sqrt{5}}{2\pi}$

139. A spherical black body with a radius of 12 cm radiates 450 watt power at 500 K. If the radius were halved and the temperature doubled, the power radiated in watt would be :

- (1) 1000
 (2) 1800
 (3) 225
 (4) 450

140. A long solenoid of diameter 0.1 m has 2×10^4 turns per meter. At the centre of the solenoid, a coil of 100 turns and radius 0.01 m is placed with its axis coinciding with the solenoid axis. The current in the solenoid reduces at a constant rate to 0A from 4 A in 0.05 s. If the resistance of the coil is $10 \pi^2 \Omega$, the total charge flowing through the coil during this time is :

- (1) $32 \mu C$
 (2) $16 \pi \mu C$
 (3) $32 \pi \mu C$
 (4) $16 \mu C$

141. Two rods A and B of different materials are welded together as shown in figure. Their thermal conductivities are K_1 and K_2 . The thermal conductivity of the composite rod will be :

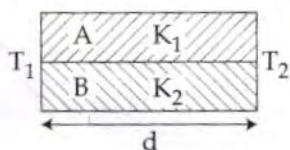

- (1) $K_1 + K_2$
 (2) $2(K_1 + K_2)$
 (3) $\frac{K_1 + K_2}{2}$
 (4) $\frac{3(K_1 + K_2)}{2}$

142. A Carnot engine having an efficiency of $\frac{1}{10}$ as heat engine, is used as a refrigerator. If the work done on the system is 10 J, the amount of energy absorbed from the reservoir at lower temperature is :

- (1) 99 J
 (2) 100 J
 (3) 1 J
 (4) 90 J

143. A spring of force constant k is cut into lengths of ratio 1 : 2 : 3. They are connected in series and the new force constant is k' . Then they are connected in parallel and force constant is k'' . Then $k' : k''$ is :

- (1) 1 : 11
 (2) 1 : 14
 (3) 1 : 6
 (4) 1 : 9

144. The de-Broglie wavelength of a neutron in thermal equilibrium with heavy water at a temperature T (Kelvin) and mass m , is :

- (1) $\frac{2h}{\sqrt{3mkT}}$
 (2) $\frac{2h}{\sqrt{mkT}}$
 (3) $\frac{h}{\sqrt{mkT}}$
 (4) $\frac{h}{\sqrt{3mkT}}$

145. Radioactive material 'A' has decay constant ' λ ' and material 'B' has decay constant ' λ' '. Initially they have same number of nuclei. After what time, the ratio of number of nuclei of material 'B' to that of 'A' will be $\frac{1}{e}$?

- (1) $\frac{1}{8\lambda}$
 (2) $\frac{1}{9\lambda}$
 (3) $\frac{1}{\lambda}$
 (4) $\frac{1}{7\lambda}$

146. Young's double slit experiment is first performed in air and then in a medium other than air. It is found that 8th bright fringe in the medium lies where 5th dark fringe lies in air. The refractive index of the medium is nearly :

- (1) 1.69
 (2) 1.78
 (3) 1.25
 (4) 1.59

147. A potentiometer is an accurate and versatile device to make electrical measurements of E.M.F. because the method involves :

- (1) a condition of no current flow through the galvanometer
- (2) a combination of cells, galvanometer and resistances
- (3) cells
- (4) potential gradients

148. The diagrams below show regions of equipotentials.

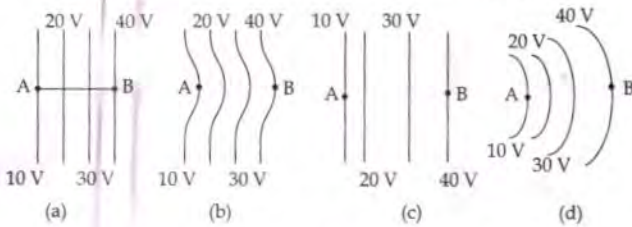

A positive charge is moved from A to B in each diagram.

- (1) Minimum work is required to move q in figure (a).
- (2) Maximum work is required to move q in figure (b).
- (3) Maximum work is required to move q in figure (c).
- (4) In all the four cases the work done is the same.

149. Two cars moving in opposite directions approach each other with speed of 22 m/s and 16.5 m/s respectively. The driver of the first car blows a horn having a frequency 400 Hz. The frequency heard by the driver of the second car is [velocity of sound 340 m/s] :

- (1) 411 Hz
- (2) 448 Hz
- (3) 350 Hz
- (4) 361 Hz

150. Which one of the following represents forward bias diode ?

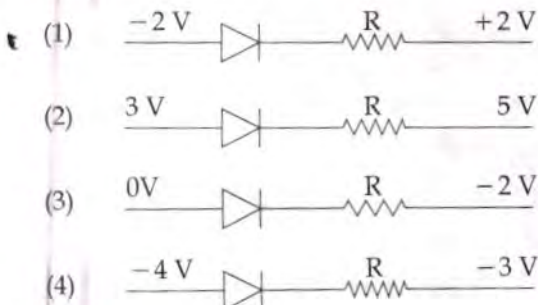

151. A thin prism having refracting angle 10° is made of glass of refractive index 1.42. This prism is combined with another thin prism of glass of refractive index 1.7. This combination produces dispersion without deviation. The refracting angle of second prism should be :

- (1) 8°
- (2) 10°
- (3) 4°
- (4) 6°

152. One end of string of length l is connected to a particle of mass ' m ' and the other end is connected to a small peg on a smooth horizontal table. If the particle moves in circle with speed ' v ', the net force on the particle (directed towards center) will be (T represents the tension in the string)

- (1) $T - \frac{mv^2}{l}$
- (2) Zero
- (3) T
- (4) $T + \frac{mv^2}{l}$

153. The x and y coordinates of the particle at any time are $x = 5t - 2t^2$ and $y = 10t$ respectively, where x and y are in meters and t in seconds. The acceleration of the particle at $t = 2s$ is :

- (1) -4 m/s^2
- (2) -8 m/s^2
- (3) 0
- (4) 5 m/s^2

154. Suppose the charge of a proton and an electron differ slightly. One of them is $-e$, the other is $(e + \Delta e)$. If the net of electrostatic force and gravitational force between two hydrogen atoms placed at a distance d (much greater than atomic size) apart is zero, then Δe is of the order of [Given mass of hydrogen $m_h = 1.67 \times 10^{-27} \text{ kg}$]

- (1) 10^{-37} C
- (2) 10^{-47} C
- (3) 10^{-20} C
- (4) 10^{-23} C

$m_h = 1.67 \times 10^{-27} \text{ kg}$

155. Which of the following statements are correct ?

- (a) Centre of mass of a body always coincides with the centre of gravity of the body.
- (b) Centre of mass of a body is the point at which the total gravitational torque on the body is zero.
- (c) A couple on a body produce both translational and rotational motion in a body.
- (d) Mechanical advantage greater than one means that small effort can be used to lift a large load.

- (1) (b) and (c)
- (2) (c) and (d)
- (3) (b) and (d)
- (4) (a) and (b)

156. The ratio of wavelengths of the last line of Balmer series and the last line of Lyman series is :

- (1) 4
- (2) 0.5
- (3) 2
- (4) 1

157. Consider a drop of rain water having mass 1g falling from a height of 1 km. It hits the ground with a speed of 50 m/s. Take 'g' constant with a value 10 m/s². The work done by the (i) gravitational force and the (ii) resistive force of air is :

- (1) (i) 100 J (ii) 8.75 J
- (2) (i) 10 J (ii) -8.75 J
- (3) (i) -10 J (ii) -8.25 J
- (4) (i) 1.25 J (ii) -8.25 J

158. The two nearest harmonics of a tube closed at one end and open at other end are 220 Hz and 260 Hz. What is the fundamental frequency of the system ?

- (1) 30 Hz
- (2) 40 Hz
- (3) 10 Hz
- (4) 20 Hz

159. Two Polaroids P_1 and P_2 are placed with their axis perpendicular to each other. Unpolarised light I_0 is incident on P_1 . A third polaroid P_3 is kept in between P_1 and P_2 such that its axis makes an angle 45° with that of P_1 . The intensity of transmitted light through P_2 is :

(1) $\frac{I_0}{8}$

(2) $\frac{I_0}{16}$

(3) $\frac{I_0}{2}$

(4) $\frac{I_0}{4}$

160. The acceleration due to gravity at a height 1 km above the earth is the same as at a depth d below the surface of earth. Then :

(1) $d = \frac{3}{2}$ km

(2) $d = 2$ km

(3) $d = \frac{1}{2}$ km

(4) $d = 1$ km

161. The bulk modulus of a spherical object is 'B'. If it is subjected to uniform pressure 'p', the fractional decrease in radius is :

(1) $\frac{3p}{B}$

(2) $\frac{p}{3B}$

(3) $\frac{p}{B}$

(4) $\frac{B}{3p}$

162. Thermodynamic processes are indicated in the following diagram.

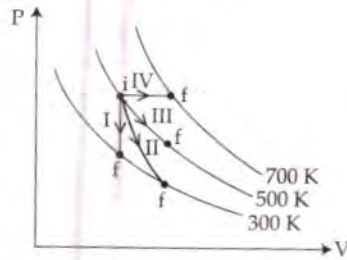

Match the following :

	Column-1		Column-2
P.	Process I	a.	Adiabatic
Q.	Process II	b.	Isobaric
R.	Process III	c.	Isochoric
S.	Process IV	d.	Isothermal

- (1) P → c, Q → d, R → b, S → a
 (2) P → d, Q → b, R → a, S → c
 (3) P → a, Q → c, R → d, S → b
 (4) P → c, Q → a, R → d, S → b
163. In an electromagnetic wave in free space the root mean square value of the electric field is $E_{\text{rms}} = 6\text{V/m}$. The peak value of the magnetic field is :
- (1) $0.70 \times 10^{-8}\text{ T}$
 (2) $4.23 \times 10^{-8}\text{ T}$
 (3) $1.41 \times 10^{-8}\text{ T}$
 (4) $2.83 \times 10^{-8}\text{ T}$
164. A rope is wound around a hollow cylinder of mass 3 kg and radius 40 cm. What is the angular acceleration of the cylinder if the rope is pulled with a force of 30 N ?
- (1) 25 rad/s^2
 (2) 5 m/s^2
 (3) 25 m/s^2
 (4) 0.25 rad/s^2

165. The given electrical network is equivalent to :

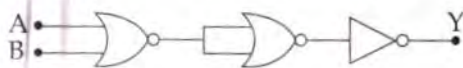

- (1) NOR gate
 (2) NOT gate
 (3) AND gate
 (4) OR gate

166. If θ_1 and θ_2 be the apparent angles of dip observed in two vertical planes at right angles to each other, then the true angle of dip θ is given by :

- (1) $\cot^2\theta = \cot^2\theta_1 - \cot^2\theta_2$
 (2) $\tan^2\theta = \tan^2\theta_1 - \tan^2\theta_2$
 (3) $\cot^2\theta = \cot^2\theta_1 + \cot^2\theta_2$
 (4) $\tan^2\theta = \tan^2\theta_1 + \tan^2\theta_2$

167. Two blocks A and B of masses 3m and m respectively are connected by a massless and inextensible string. The whole system is suspended by a massless spring as shown in figure. The magnitudes of acceleration of A and B immediately after the string is cut, are respectively :

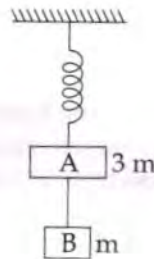

- (1) g, g
 (2) $\frac{g}{3}, \frac{g}{3}$
 (3) $g, \frac{g}{3}$
 (4) $\frac{g}{3}, g$
168. Two discs of same moment of inertia rotating about their regular axis passing through centre and perpendicular to the plane of disc with angular velocities ω_1 and ω_2 . They are brought into contact face to face coinciding the axis of rotation. The expression for loss of energy during this process is :

- (1) $I(\omega_1 - \omega_2)^2$
 (2) $\frac{1}{8}(\omega_1 - \omega_2)^2$
 (3) $\frac{1}{2}I(\omega_1 + \omega_2)^2$
 (4) $\frac{1}{4}I(\omega_1 - \omega_2)^2$

169. A 250 - Turn rectangular coil of length 2.1 cm and width 1.25 cm carries a current of $85 \mu\text{A}$ and subjected to a magnetic field of strength 0.85 T . Work done for rotating the coil by 180° against the torque is :

- (1) $2.3 \mu\text{J}$
- (2) $1.15 \mu\text{J}$
- (3) $9.1 \mu\text{J}$
- (4) $4.55 \mu\text{J}$

170. A capacitor is charged by a battery. The battery is removed and another identical uncharged capacitor is connected in parallel. The total electrostatic energy of resulting system :

- (1) remains the same
- (2) increases by a factor of 2
- (3) increases by a factor of 4
- (4) decreases by a factor of 2

171. Two astronauts are floating in gravitational free space after having lost contact with their spaceship. The two will :

- (1) move away from each other.
- (2) will become stationary.
- (3) keep floating at the same distance between them.
- (4) move towards each other.

172. A beam of light from a source L is incident normally on a plane mirror fixed at a certain distance x from the source. The beam is reflected back as a spot on a scale placed just above the source L. When the mirror is rotated through a small angle θ , the spot of the light is found to move through a distance y on the scale. The angle θ is given by :

- (1) $\frac{x}{2y}$
- (2) $\frac{x}{y}$
- (3) $\frac{y}{2x}$
- (4) $\frac{y}{x}$

173. In a common emitter transistor amplifier the audio signal voltage across the collector is 3 V . The resistance of collector is $3 \text{ k}\Omega$. If current gain is 100 and the base resistance is $2 \text{ k}\Omega$, the voltage and power gain of the amplifier is :

- (1) 150 and 15000
- (2) 20 and 2000
- (3) 200 and 1000
- (4) 15 and 200

174. Figure shows a circuit that contains three identical resistors with resistance $R = 9.0 \Omega$ each, two identical inductors with inductance $L = 2.0 \text{ mH}$ each, and an ideal battery with emf $\epsilon = 18 \text{ V}$. The current 'i' through the battery just after the switch closed is,.....

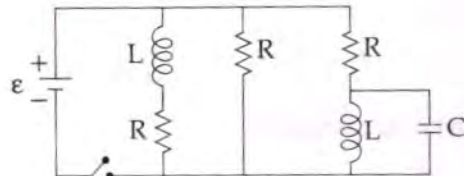

- (1) 2 A
- (2) 0 ampere
- (3) 2 mA
- (4) 0.2 A

175. A U tube with both ends open to the atmosphere, is partially filled with water. Oil, which is immiscible with water, is poured into one side until it stands at a distance of 10 mm above the water level on the other side. Meanwhile the water rises by 65 mm from its original level (see diagram). The density of the oil is :

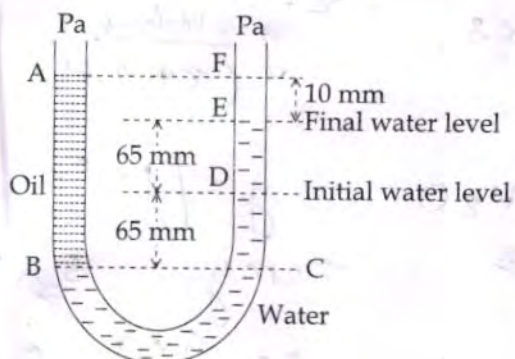

- (1) 800 kg m^{-3}
 (2) 928 kg m^{-3}
 (3) 650 kg m^{-3}
 (4) 425 kg m^{-3}
176. The photoelectric threshold wavelength of silver is $3250 \times 10^{-10} \text{ m}$. The velocity of the electron ejected from a silver surface by ultraviolet light of wavelength $2536 \times 10^{-10} \text{ m}$ is :
 (Given $h = 4.14 \times 10^{-15} \text{ eVs}$ and $c = 3 \times 10^8 \text{ ms}^{-1}$)
- (1) $\approx 61 \times 10^3 \text{ ms}^{-1}$
 (2) $\approx 0.3 \times 10^6 \text{ ms}^{-1}$
 (3) $\approx 6 \times 10^5 \text{ ms}^{-1}$
 (4) $\approx 0.6 \times 10^6 \text{ ms}^{-1}$
177. A physical quantity of the dimensions of length that can be formed out of c , G and $\frac{e^2}{4\pi\epsilon_0}$ is [c is velocity of light, G is universal constant of gravitation and e is charge] :

(1) $\frac{1}{c^2} \left[\frac{e^2}{G 4\pi\epsilon_0} \right]^{1/2}$

(2) $\frac{1}{c} G \frac{e^2}{4\pi\epsilon_0}$

(3) $\frac{1}{c^2} \left[G \frac{e^2}{4\pi\epsilon_0} \right]^{1/2}$

(4) $c^2 \left[G \frac{e^2}{4\pi\epsilon_0} \right]^{1/2}$

178. The ratio of resolving powers of an optical microscope for two wavelengths $\lambda_1 = 4000 \text{ \AA}$ and $\lambda_2 = 6000 \text{ \AA}$ is :

- (1) 3 : 2
 (2) 16 : 81
 (3) 8 : 27
 (4) 9 : 4

179. A gas mixture consists of 2 moles of O_2 and 4 moles of Ar at temperature T . Neglecting all vibrational modes, the total internal energy of the system is :

- (1) 9 RT
 (2) 11 RT
 (3) 4 RT
 (4) 15 RT

180. The resistance of a wire is 'R' ohm. If it is melted and stretched to 'n' times its original length, its new resistance will be :

- (1) $n^2 R$
 (2) $\frac{R}{n^2}$
 (3) nR
 (4) $\frac{R}{n}$

- o O o -